

# XF3M

FPC/FFC用

旋转后锁方式(0.5mm间距、1.0mm间距双面触点型、上触点型)

利用旋转后锁方式，  
改善了FPC/FFC电缆的连接器插入性，  
实现了可确认操作完成的锁定感。

- 备有同一构造0.5mm、1.0mm间距的两种产品。
- 接点构造备有双面触点型和上触点型两种。  
(上触点型只有0.5mm间距)
- 备有镀金、镀锡两种。(镀锡仅限2接点型)
- 还有0.5mm间距80极(多极)型。
- 适用FPC / FFC厚度 $t=0.3\text{mm}$ 。
- 应对无卤化。(※)

※本公司的无卤化标准为：溴(Br) 900ppm以下、氯(Cl) 900ppm以下、  
卤合计(Br+Cl) 1,500ppm。

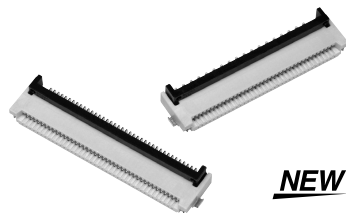

NEW

符合RoHS

## ■额定值/性能

额定电流	AC/DC0.5A
额定电压	AC/DC50V
接触电阻	50mΩ以下(DC20mV以下、100mA以下时)
绝缘电阻	100MΩ以上(DC250V时)
耐压	AC250V 1min(漏电流1mA以下)
插拔寿命	镀金: 20次
	镀锡: 10次
使用温度范围	-30~+85℃(无结冰、无凝露)

## ■材质/处理

项目	双面触点型		上触点型
	镀金型	镀锡型	镀金型
外壳	LCP树脂(UL94 V-0)/天然色		LCP树脂 (UL94 V-0)/ 灰色
滑片	LCP树脂(UL94 V-0)/黑色		
触点	弹簧用铜合金/镍底(1.5μm)		
	接触部 镀金 (薄层)	接触部 镀锡 (1μm)	接触部 镀金 (薄层)
底板	铜合金/镀锡(1μm)		

■型号标准 (产品种类请参阅相关页的“■种类”。)

XF3M□-□□□5-1□□-□

① ② ③④⑤⑥⑦ ⑧

### ①系列内部区分

3M : 0.5mm间距  
3M (1) : 1.0mm间距

### ③触点排列

1: 双面接触(双面触点)  
2: 单面接触(上触点)

### ⑤适用FPC/FFC厚度 ⑦滑片规格

1: 0.3mm  
E : 高操作性型

### ②信号触点极数

5: SMT端子  
(侧入式)

### ④电镀规格

B: 薄镀金  
D: Sn

### ⑧包装数量

R100: 100个(小包装对应)

XF3M

### XF3M 0.5mm间距型

#### ■外形尺寸

- XF3M-□□15-1B
- XF3M-□□15-1BE
- XF3M-□□15-1D
- XF3M-□□25-1B

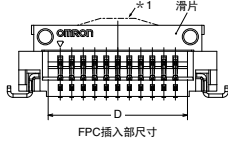
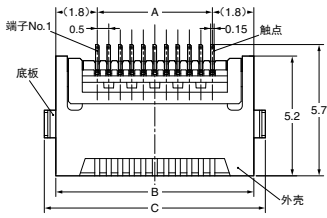

印刷基板加工尺寸 (顶视图)

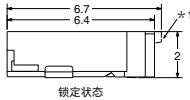
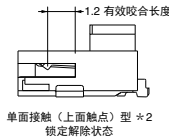
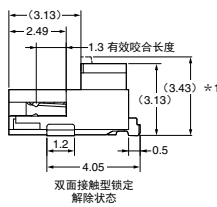
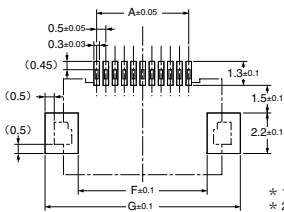

推荐FPC / FFC尺寸

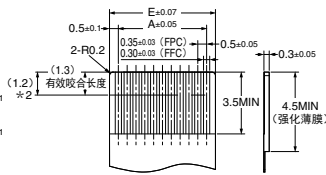

\* 1虚线的形状和数值为XF3M-8015-1BE型的情况。  
\* 2为XF3M-□□25-1B型的情况。

尺寸表

极数	A	B	C	D	E	F	G
6	2.5	6.1	7.1	3.55	3.5	4.5	8.1
7	3.0	6.6	7.6	4.05	4.0	5.0	8.6
8	3.5	7.1	8.1	4.55	4.5	5.5	9.1
9	4.0	7.6	8.6	5.05	5.0	6.0	9.6
10	4.5	8.1	9.1	5.55	5.5	6.5	10.1
11	5.0	8.6	9.6	6.05	6.0	7.0	10.6
12	5.5	9.1	10.1	6.55	6.5	7.5	11.1
13	6.0	9.6	10.6	7.05	7.0	8.0	11.6
14	6.5	10.1	11.1	7.55	7.5	8.5	12.1
15	7.0	10.6	11.6	8.05	8.0	9.0	12.6
16	7.5	11.1	12.1	8.55	8.5	9.5	13.1
17	8.0	11.6	12.6	9.05	9.0	10.0	13.6
18	8.5	12.1	13.1	9.55	9.5	10.5	14.1
19	9.0	12.6	13.6	10.05	10.0	11.0	14.6
20	9.5	13.1	14.1	10.55	10.5	11.5	15.1
21	10.0	13.6	14.6	11.05	11.0	12.0	15.6
22	10.5	14.1	15.1	11.55	11.5	12.5	16.1
23	11.0	14.6	15.6	12.05	12.0	13.0	16.6
24	11.5	15.1	16.1	12.55	12.5	13.5	17.1
25	12.0	15.6	16.6	13.05	13.0	14.0	17.6
26	12.5	16.1	17.1	13.55	13.5	14.5	18.1
28	13.5	17.1	18.1	14.55	14.5	15.5	19.1
30	14.5	18.1	19.1	15.55	15.5	16.5	20.1
31	15.0	18.6	19.6	16.05	16.0	17.0	20.6
32	15.5	19.1	20.1	16.55	16.5	17.5	21.1
33	16.0	19.6	20.6	17.05	17.0	18.0	21.6
34	16.5	20.1	21.1	17.55	17.5	18.5	22.1
35	17.0	20.6	21.6	18.05	18.0	19.0	22.6
36	17.5	21.1	22.1	18.55	18.5	19.5	23.1
37	18.0	21.6	22.6	19.05	19.0	20.0	23.6
40	19.5	23.1	24.1	20.55	20.5	21.5	25.1
41	20.0	23.6	24.6	21.05	21.0	22.0	25.6
45	22.0	25.6	26.6	23.05	23.0	24.0	27.6
50	24.5	28.1	29.1	25.55	25.5	26.5	30.1
53	26.0	29.6	30.6	27.05	27.0	28.0	31.6
60	29.5	33.1	34.1	30.55	30.5	31.5	35.1
80	39.5	43.1	44.1	40.55	40.5	41.5	45.1

## ■种类

## ●双面触点型-镀金型

## 标准卷

极数*1	型号	极数*1	型号	极数*1	型号	极数*1	型号	每卷个数 (个)*2
6	XF3M-0615-1B	16	XF3M-1615-1B	(26)	XF3M-2615-1B	40	XF3M-4015-1B	1,500
7	XF3M-0715-1B	17	XF3M-1715-1B	(28)	XF3M-2815-1B	41	XF3M-4115-1B	
8	XF3M-0815-1B	18	XF3M-1815-1B	30	XF3M-3015-1B	45	XF3M-4515-1B	
9	XF3M-0915-1B	19	XF3M-1915-1B	31	XF3M-3115-1B	50	XF3M-5015-1B	
10	XF3M-1015-1B	20	XF3M-2015-1B	32	XF3M-3215-1B	(53)	XF3M-5315-1B	
11	XF3M-1115-1B	21	XF3M-2115-1B	33	XF3M-3315-1B	60	XF3M-6015-1B	
12	XF3M-1215-1B	22	XF3M-2215-1B	34	XF3M-3415-1B	80	XF3M-8015-1BE	
13	XF3M-1315-1B	23	XF3M-2315-1B	(35)	XF3M-3515-1B			
14	XF3M-1415-1B	24	XF3M-2415-1B	36	XF3M-3615-1B			
15	XF3M-1515-1B	25	XF3M-2515-1B	37	XF3M-3715-1B			

## 小卷

极数*1	型号	极数*1	型号	极数*1	型号	极数*1	型号	每卷个数 (个)*2
6	XF3M-0615-1B-R100	16	XF3M-1615-1B-R100	(26)	XF3M-2615-1B-R100	40	XF3M-4015-1B-R100	100
7	XF3M-0715-1B-R100	17	XF3M-1715-1B-R100	(28)	XF3M-2815-1B-R100	41	XF3M-4115-1B-R100	
8	XF3M-0815-1B-R100	18	XF3M-1815-1B-R100	30	XF3M-3015-1B-R100	45	XF3M-4515-1B-R100	
9	XF3M-0915-1B-R100	19	XF3M-1915-1B-R100	31	XF3M-3115-1B-R100	50	XF3M-5015-1B-R100	
10	XF3M-1015-1B-R100	20	XF3M-2015-1B-R100	(32)	XF3M-3215-1B-R100	(53)	XF3M-5315-1B-R100	
11	XF3M-1115-1B-R100	21	XF3M-2115-1B-R100	33	XF3M-3315-1B-R100	60	XF3M-6015-1B-R100	
12	XF3M-1215-1B-R100	22	XF3M-2215-1B-R100	34	XF3M-3415-1B-R100	80	XF3M-8015-1BE-R100	
13	XF3M-1315-1B-R100	23	XF3M-2315-1B-R100	(35)	XF3M-3515-1B-R100			
14	XF3M-1415-1B-R100	24	XF3M-2415-1B-R100	36	XF3M-3615-1B-R100			
15	XF3M-1515-1B-R100	25	XF3M-2515-1B-R100	37	XF3M-3715-1B-R100			

## ●双面触点型-镀锡型

## 标准卷

极数*1	型号	极数*1	型号	极数*1	型号	每卷个数 (个)*2
(6)	XF3M-0615-1D	(11)	XF3M-1115-1D	(16)	XF3M-1615-1D	1500
(7)	XF3M-0715-1D	(12)	XF3M-1215-1D	(17)	XF3M-1715-1D	
(8)	XF3M-0815-1D	(13)	XF3M-1315-1D	(18)	XF3M-1815-1D	
(9)	XF3M-0915-1D	(14)	XF3M-1415-1D	(19)	XF3M-1915-1D	
10	XF3M-1015-1D	(15)	XF3M-1515-1D	(20)	XF3M-2015-1D	

## 小卷

极数*1	型号	极数*1	型号	极数*1	型号	每卷个数 (个)*2
(6)	XF3M-0615-1D-R100	(11)	XF3M-1115-1D-R100	(16)	XF3M-1615-1D-R100	100
(7)	XF3M-0715-1D-R100	(12)	XF3M-1215-1D-R100	(17)	XF3M-1715-1D-R100	
(8)	XF3M-0815-1D-R100	(13)	XF3M-1315-1D-R100	(18)	XF3M-1815-1D-R100	
(9)	XF3M-0915-1D-R100	(14)	XF3M-1415-1D-R100	(19)	XF3M-1915-1D-R100	
10	XF3M-1015-1D-R100	(15)	XF3M-1515-1D-R100	(20)	XF3M-2015-1D-R100	

## ●上触点型-镀金型

## 标准卷

极数*1	型号	极数*1	型号	极数*1	型号	每卷个数 (个)*2
(6)	XF3M-0625-1B	(12)	XF3M-1225-1B	18	XF3M-1825-1B	1500
(7)	XF3M-0725-1B	(13)	XF3M-1325-1B	(19)	XF3M-1925-1B	
(8)	XF3M-0825-1B	(14)	XF3M-1425-1B	20	XF3M-2025-1B	
(9)	XF3M-0925-1B	(15)	XF3M-1525-1B	40	XF3M-4025-1B	
10	XF3M-1025-1B	(16)	XF3M-1625-1B			
(11)	XF3M-1125-1B	(17)	XF3M-1725-1B			

## 小卷

极数*1	型号	极数*1	型号	极数*1	型号	每卷个数 (个)*2
(6)	XF3M-0625-1B-R100	(12)	XF3M-1225-1B-R100	18	XF3M-1825-1B-R100	100
(7)	XF3M-0725-1B-R100	(13)	XF3M-1325-1B-R100	(19)	XF3M-1925-1B-R100	
(8)	XF3M-0825-1B-R100	(14)	XF3M-1425-1B-R100	20	XF3M-2025-1B-R100	
(9)	XF3M-0925-1B-R100	(15)	XF3M-1525-1B-R100	40	XF3M-4025-1B-R100	
10	XF3M-1025-1B-R100	(16)	XF3M-1625-1B-R100			
(11)	XF3M-1125-1B-R100	(17)	XF3M-1725-1B-R100			

\*1. 关于极数信息请咨询销售人员。( ) 极数的上市时间请咨询销售人员。

\*2. 请按每卷个数的整数倍订购。

### XF3M(1) 1.0mm间距型

#### ■外形尺寸

XF3M(1)-□□15-1B

XF3M(1)-□□15-1D

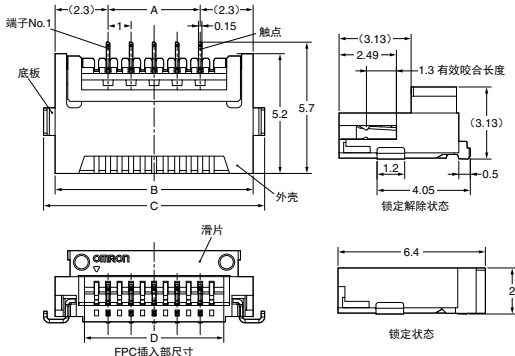

尺寸表

极数	A	B	C	D	E	F	G
4	3.0	7.6	8.6	5.05	5.0	6.0	9.6
5	4.0	8.6	9.6	6.05	6.0	7.0	10.6
6	5.0	9.6	10.6	7.05	7.0	8.0	11.6
7	6.0	10.6	11.6	8.05	8.0	9.0	12.6
8	7.0	11.6	12.6	9.05	9.0	10.0	13.6
9	8.0	12.6	13.6	10.05	10.0	11.0	14.6
10	9.0	13.6	14.6	11.05	11.0	12.0	15.6
11	10.0	14.6	15.6	12.05	12.0	13.0	16.6
12	11.0	15.6	16.6	13.05	13.0	14.0	17.6
15	14.0	18.6	19.6	16.05	16.0	17.0	20.6
16	15.0	19.6	20.6	17.05	17.0	18.0	21.6
17	16.0	20.6	21.6	18.05	18.0	19.0	22.6
18	17.0	21.6	22.6	19.05	19.0	20.0	23.6
20	19.0	23.6	24.6	21.05	21.0	22.0	25.6
22	21.0	25.6	26.6	23.05	23.0	24.0	27.6
26	25.0	29.6	30.6	27.05	27.0	28.0	31.6
30	29.0	33.6	34.6	31.05	31.0	32.0	35.6

#### ■种类

##### ●双面触点型-镀金型

##### 标准卷

极数*1	型号	极数*1	型号	极数*1	型号	极数*1	型号	每卷个数 (个)*2
4	XF3M (1)-0415-1B	9	XF3M (1)-0915-1B	16	XF3M (1)-1615-1B	(26)	XF3M (1)-2615-1B	1,500
5	XF3M (1)-0515-1B	10	XF3M (1)-1015-1B	(17)	XF3M (1)-1715-1B	30	XF3M (1)-3015-1B	
6	XF3M (1)-0615-1B	11	XF3M (1)-1115-1B	18	XF3M (1)-1815-1B			
7	XF3M (1)-0715-1B	12	XF3M (1)-1215-1B	20	XF3M (1)-2015-1B			
8	XF3M (1)-0815-1B	15	XF3M (1)-1515-1B	22	XF3M (1)-2215-1B			

##### 小卷

极数*1	型号	极数*1	型号	极数*1	型号	极数*1	型号	每卷个数 (个)*2
4	XF3M (1)-0415-1B-R100	9	XF3M (1)-0915-1B-R100	16	XF3M (1)-1615-1B-R100	(26)	XF3M (1)-2615-1B-R100	100
5	XF3M (1)-0515-1B-R100	10	XF3M (1)-1015-1B-R100	(17)	XF3M (1)-1715-1B-R100	30	XF3M (1)-3015-1B-R100	
6	XF3M (1)-0615-1B-R100	11	XF3M (1)-1115-1B-R100	18	XF3M (1)-1815-1B-R100			
7	XF3M (1)-0715-1B-R100	12	XF3M (1)-1215-1B-R100	20	XF3M (1)-2015-1B-R100			
8	XF3M (1)-0815-1B-R100	15	XF3M (1)-1515-1B-R100	22	XF3M (1)-2215-1B-R100			

##### ●双面触点型-镀锡型

##### 标准卷

极数*1	型号	极数*1	型号	极数*1	型号	每卷个数 (个)*2
(4)	XF3M (1)-0415-1D	(9)	XF3M (1)-0915-1D	(16)	XF3M (1)-1615-1D	1,500
(5)	XF3M (1)-0515-1D	10	XF3M (1)-1015-1D	(17)	XF3M (1)-1715-1D	
(6)	XF3M (1)-0615-1D	(11)	XF3M (1)-1115-1D	(18)	XF3M (1)-1815-1D	
(7)	XF3M (1)-0715-1D	(12)	XF3M (1)-1215-1D	(20)	XF3M (1)-2015-1D	
(8)	XF3M (1)-0815-1D	(15)	XF3M (1)-1515-1D			

##### 小卷

极数*1	型号	极数*1	型号	极数*1	型号	每卷个数 (个)*2
(4)	XF3M (1)-0415-1D-R100	(9)	XF3M (1)-0915-1D-R100	(16)	XF3M (1)-1615-1D-R100	100
(5)	XF3M (1)-0515-1D-R100	10	XF3M (1)-1015-1D-R100	(17)	XF3M (1)-1715-1D-R100	
(6)	XF3M (1)-0615-1D-R100	(11)	XF3M (1)-1115-1D-R100	(18)	XF3M (1)-1815-1D-R100	
(7)	XF3M (1)-0715-1D-R100	(12)	XF3M (1)-1215-1D-R100	(20)	XF3M (1)-2015-1D-R100	
(8)	XF3M (1)-0815-1D-R100	(15)	XF3M (1)-1515-1D-R100			

\*1. 关于极数信息请咨询销售人员。( ) 极数的上市时间请咨询销售人员。

\*2. 请按每卷个数的整数倍订购。